



CADS Revit to SCIA Engineer

Release notes

Contents

Release Notes	1
Version 2024.2 (Build 680): March 2024	1
Corrections made:.....	1
Version 2024.1 (Build 670): January 2024	1
Enhancements:	1
Version 2024.0 (Build 664): October 2023	1
Enhancements:	1
Corrections made:.....	2
Version 2023.1 (Build 619): March 2023	2
Corrections made:.....	2
Version 2023.0 (Build 607): September 2022	2
Enhancements:	2
Corrections made:.....	2
Version 2022.1 (Build 520): October 2021	2
Corrections made:.....	2
Version 2022.0 (Build 514): May 2021.....	3
Enhancements:	3
Corrections made:.....	3
Version 2021.1 (Build 496): October 2020	3
Corrections made:.....	3
Version 2021.0 (Build 491): May 2020.....	3
Enhancements:	3
Version 2020.2(Build 485): March 2020	4
Enhancements:	4
Corrections made:.....	4
Version 2020.1(Build 464): August 2019	4
Enhancements:	4
Corrections made:.....	4
Version 2020 (Build 452): April 2019	5
Corrections made:.....	5
Version 2019.2 (Build 440): September 2018.....	5
Enhancements:	5
Corrections made:.....	5
Version 2019.1 (Build 434): June 2018	6



Release notes

Enhancements:	6
Corrections made:.....	6
Version 2019 (Build 421): May 2018.....	6
Enhancements:	6
Corrections made:.....	7
Version 2018.1 (Build 363): November 2017.....	7
Enhancements:	7
Corrections made:.....	8
Version 2018 (Build 328): June 2017	8
Corrections made:.....	8
Version 2018 (Build 320): June 2017	8
Enhancements:	8
Corrections made:.....	9
Version 2017 (Build 297): June 2016	9
Enhancements:	9
Corrections made:.....	10
Version 2016 (Build 280): May 2015.....	10
Enhancements:	10
Corrections made:.....	10
Version 3.1 (Build 268): December 2014.....	11
Enhancements:	11
Corrections made:.....	13
Version 3.0 (Build 254): May 2014.....	13
Enhancements:	13
Corrections made:.....	15
Version 2.2 (Build 244): June 2013	15
Enhancements:	15
Version 2.1 (Build 220): July 2012.....	17
Enhancements:	17
Version 1.5 (Build 195): May 2010.....	17
Enhancements:	17
Limitation:.....	17
Version 1.4 (Build 177): August 2009.....	18
Enhancements:	18
Version 1.3 (Build 173): July 2008.....	18
Enhancements:	18
Corrections made:.....	18
Version 1.3 (Build 169): May 2008.....	19



Release notes

Enhancements: 19
Corrections made:..... 19
Version 1.2 (Build 153): December 2007 20
Enhancements: 20
Corrections made:..... 20
Known Issues..... 21



Release Notes

Thank you for upgrading to the latest version of CADS Revit SCIA Engineer Link.

These release notes summarise the enhancements and corrections made.

The versions supported for the current release are:

Revit 2024, Revit 2023	SCIA Engineer 24.0, 22.1, 22.0
------------------------	--------------------------------

Version 2024.2 (Build 680): March 2024

Corrections made:

1. There was an issue while importing the reinforcements from SCIA Engineer 24 into Revit. This has been fixed now.

Version 2024.1 (Build 670): January 2024

Enhancements:

1. Updated the software to support SCIA Engineer 2024.

Version 2024.0 (Build 664): October 2023

Enhancements:

The link software has now been extended to support Revit 2024, with the following enhancements:

1. Revit 2024 enhancements for Physical-Analytical element association and analytical loads are now supported;
2. You can export the Revit model to SCIA Engineer with the National code SIA 26x;
3. Improvements have been made to the export/import and update of point loads, line loads and area loads;
4. The analytical geometry of 2D members is now updated in the round trip;
5. 2D members with the structural role of 'Analytical panel' can be exported as load panels to SCIA Engineer, with support for openings in load panels;
6. Import/update of load panels have been improved.

Corrections made:

1. Some users experienced issues when uninstalling the link. This issue has now been fixed;
2. In some cases, the 2D members were not imported. This issue has now been fixed;
3. Previously, modifying the reference line position wasn't checked during the 'Review & Update' workflow. This has now been fixed.

Version 2023.1 (Build 619): March 2023

Corrections made:

1. In some cases, there were issues with the calculation of the positions and number of stirrups. This issue has now been fixed.
2. For some users, there was an issue in selection of SCIA Engineer version. This issue has now been fixed.

Version 2023.0 (Build 607): September 2022

Enhancements:

1. The link software has now been extended to support Revit 2023 including the new feature "Contextual analytical model" in Revit 2023;
2. You can now specify whether to export the analytical elements or structural elements or both analytical and structural elements while exporting the model to SCIA Engineer;
3. While importing the model from SCIA Engineer, you can now specify whether to create structural elements or analytical elements or both structural and analytical elements for the model being imported.

Corrections made:

1. There was an issue with importing "Gable columns" and "Secondary columns". This issue has now been fixed.

Version 2022.1 (Build 520): October 2021

Corrections made:

1. For some users, there was an issue in copying the data into the local folder. This issue has now been fixed.

2. There was an issue while importing the reinforcement with the Portuguese localization of SCIA Engineer. This issue is now fixed.
3. In some cases, there was an exception during select and import of members from SCIA Engineer. This issue is now fixed.

Version 2022.0 (Build 514): May 2021

Enhancements:

1. Support for Revit 2022.
2. An option to export members by grouping them based on their length has been added.
3. Analytical links in Revit are now exported as rigid arms.
4. A new option has been added that will allow/prevent Revit's analytical alignment feature to be applied on the model before importing it into Revit.

Corrections made:

1. In file exchange mode, there was an issue with update of deleted members from SCIA Engineer to Revit. This issue is now fixed.
2. The logic of identifying the installed version of Revit is now improved.

Version 2021.1 (Build 496): October 2020

Corrections made:

1. In file exchange mode, there was an issue with update of deleted members from SCIA Engineer to Revit. This issue is now fixed.
2. In some cases, duplicate nodes were exported from Revit to SCIA Engineer. This issue is now fixed.
3. Rigid links between concrete sections were not exported from Revit to SCIA Engineer. This issue is now fixed.

Version 2021.0 (Build 491): May 2020

Enhancements:

1. Support for Revit 2021.

Version 2020.2(Build 485): March 2020

Enhancements:

1. The reinforcements in beams and columns from Revit can now be exported to SCIA Engineer as PRAD reinforcement. Beams with rectangle, T and L cross-sections and columns with rectangle and circular sections are supported.
2. The openings in slab from Revit can now optionally be exported as “Panels” to SCIA Engineer.
3. The PRAD reinforcements in columns with circular sections can now be imported from SCIA Engineer 19.1 to Revit.
4. The beams modelled using Hermite spline curve in Revit can now be exported to SCIA Engineer.

Corrections made:

1. When the supports are defined as point boundary conditions in Revit, the supports were deleted while updating the SCIA Engineer model. The issue is now fixed.
2. When the stories are modelled in SCIA Engineer, in some cases, the model was not imported into Revit. This issue is now fixed.
3. There was an issue with import and update of SlimFlor beams. This issue is now fixed.
4. In some cases, the virtual beam design and composite beam design info were not imported from SCIA Engineer to Revit. This issue is now fixed.
5. When the Revit model had free loads, the export to SCIA Engineer failed in some cases. The issue is now fixed.

Version 2020.1(Build 464): August 2019

Enhancements:

1. Import of practical reinforcement from SCIA Engineer 19.1 to Revit. In this release, Rectangle, T and L cross-sections are supported.
2. Surface supports/boundary conditions for plates can now be exported from Revit to SCIA Engineer as “Elastic foundation” with default values.

Corrections made:

1. The export of the analytical curve from Revit to SCIA Engineer was incorrect, this is now fixed.
2. There was an issue with mapping the parameters for certain sections while importing the model into Revit when the language was set to French. This is now fixed.
3. In some cases, while updating the Revit model the alignment of frames was incorrect. The issue is now fixed.

4. Fixed an issue with the import of longitudinal reinforcement and stirrups, when SCIA Engineer's language was set to Dutch.
5. Longitudinal reinforcements are not imported when the material of the reinforcement is not in the mapping table. The issue is now fixed by prompting the user to map the reinforcement materials during materials mapping.
6. When a model is imported from SCIA Engineer to Revit, the location and the project name of the .esa file is now stored in Revit. In this case, the SCIA Engineer model can be updated even if the Revit file is stored in a different location.

Version 2020 (Build 452): April 2019

Corrections made:

1. An issue with export of foundation blocks from Revit to SCIA Engineer is now fixed.
2. While importing the 2D reinforcement from SCIA Engineer to Revit, there was an issue if the reinforcement is created at an angle; this issue is fixed now.
3. While importing the model from Revit to SCIA Engineer, a wall element with invalid geometry stopped the import process. The invalid wall elements are now ignored while exporting the rest of the model from Revit.
4. Element names such as Beam, Column, Plate and Wall are now translated.

Version 2019.2 (Build 440): September 2018

Enhancements:

1. Structural members (frames, columns, plates and walls) can be exported to different layers from Revit to SCIA Engineer.
2. A new option will allow the user to export the element names defined in the identity data. The element names will be updated while importing the model from SCIA Engineer.

Corrections made:

1. An issue with mapping the cross section with the family names has been fixed.
2. While importing the Rebars from SCIA Engineer to Revit, the position of Rebars in rectangular cross section was incorrect in Revit 2018 and is fixed now.
3. In some cases, loads were not exported to SCIA Engineer and this issue has been fixed now.
4. An issue with import of Virtual joist design info was incorrect in some instances which is now fixed.
5. LCS rotation angle for Joist girders is now corrected.

Version 2019.1 (Build 434): June 2018

Enhancements:

1. Introduced reinforcement mapping while transferring data from Revit to SCIA Engineer and vice versa.
2. The property “Projected loads” is now considered during the export and import of members between Revit and SCIA Engineer.
3. Walls with circular openings can be imported from SCIA Engineer to Revit.

Corrections made:

1. Improved log message when the geometry of 2D reinforcement is defined using line or point.
2. Fixed an issue with the export of walls when the language set in SCIA Engineer is other than English.
3. Fixed an issue with the export of walls with openings.

Version 2019 (Build 421): May 2018

Enhancements:

1. Support for 64-bit version of SCIA Engineer.
2. User defined reinforcement for 1D and 2D members can now be imported into Revit.
3. The user interface for mapping tables is revamped to make the mapping easier. A profile library dialog is created to select the standard steel sections easily.
4. Materials, sections and profiles can be mapped directly from the ribbon. The mapped details can be saved into a database to share it across various users.
5. Mapping algorithm for cross section mapping is re-written with new algorithm. The new algorithm doesn't require the mapping databases for section mapping. Hence the databases for section mapping are removed. The options “preferred databases” and the “mapping rules” are also removed from the user interface.
6. Stories in SCIA Engineer can now be imported as “Levels” in Revit. New options are introduced to create levels in Revit. The levels could be created based on height of stories, elevation of slabs or z coordinates of elements.
7. For Virtual Joist girders with the design info, the number of joist spaces and the point load on each panel will be added as properties in Revit while importing the model from SCIA Engineer.
8. New CADs families are deployed to support the import of Geometric, Welded, Thin-walled, Build-in-Beams, Closed sections from SCIA Engineer to Revit. All the CADs families are now defined with Structural shape and dimensional properties.

9. Load panels in SCIA Engineer can now be imported into Revit as a Floors using floor family.
10. Generated loads on load panels can be excluded while importing the loads from SCIA Engineer to Revit.
11. Only the member size, material, thickness can be updated back to Revit model from SCIA Engineer using a new option. This feature will allow the user to make required adjustments in the analytical model in SCIA engineer and can ignore these geometry changes while updating the model back to Revit.
12. Parameter mapping is extended for Steel sections to enable the users to export the Revit families for welded sections into SCIA Engineer.
13. Cross-section mapping is extended to support families defined with Standard steel profiles and parameters (Slim Floor Beams, Paired sections and closed sections).
14. Revit families can now be exported as Pairs, Closed, Welded, Sheet welded, Build-in beams, Thin-walled geometric sections in SCIA Engineer.
15. Now, exporting the model from Revit as an r2s file doesn't require the SCIA Engineer version to be installed on the machine.
16. Exporting the model from Revit to SCIA Engineer in "Direct exchange" mode will now also work for "Student version" of SCIA Engineer.

Corrections made:

4. Default material properties (Colour and Physical properties) are assigned to Revit materials.
5. An issue with assigning the "state" for the combinations while importing the load combinations from SCIA Engineer is now fixed.
6. The issue with importing the Trapezoidal loads is now fixed.
7. Partial loads can now be imported from SCIA Engineer as free loads into Revit.
8. The issues with importing the loads defined in LCS is now fixed.
9. An issue with reading the geometry of 2D elements which causes invalid 2D geometry has been fixed.

Version 2018.1 (Build 363): November 2017

Enhancements:

1. Support for Revit 2018.1 and SCIA Engineer 17.1.
2. The application is now made language independent.
3. Support for composite slabs and steel joist bar from Revit to SCIA Engineer and vice versa.
4. Import of composite beam design info and virtual joist design info from SCIA Engineer to Revit.
5. Alpha rotation of members "Y by Vector" in SCIA Engineer is now considered while importing the members in Revit.

6. New option to map “By category” materials for Steel, Concrete and Timber separately from Revit to SCIA Engineer.
7. New database for standard Revit SFB’s. SFB’s made with sections HE, HEA, HEB, HEC, HEM, I, I(CH), INP, IPE and IPN can now be imported using standard CADs families.

Corrections made:

1. Import of members with General cross-sections from SCIA Engineer to Revit.
2. Load cases are ignored when the user chooses to ignore the loads, load combinations and analysis results from SCIA Engineer.
3. Issues with the cross section rotation tolerance is now fixed.
4. Added/corrected warning messages while importing the point boundary condition for slabs from SCIA Engineer to Revit.
5. Corrected the warning message if one or more members are not mapped during import.
6. Fixed the issues with changes in number of nodes/edges in Revit for 2D members during roundtrip.
7. Issues with deletion of members in roundtrip is now fixed.
8. Issues with reading the load group and load combination name while importing the model from SCIA Engineer to Revit is now fixed.
9. If the mapped Revit family is not found in the Revit family path, a warning message is now shown in section mapping dialog.
10. Issues with reading the geometry of the wall while exporting the model from Revit to SCIA Engineer is now fixed.
11. Issues with selection of materials for while exporting the model from Revit to SCIA Engineer 17.01 is now fixed.

Version 2018 (Build 328): June 2017

Corrections made:

1. Various bug fixes.

Version 2018 (Build 320): June 2017

Enhancements:

1. Support for Revit 2018 and SCIA Engineer 17.
2. A unified user interface is introduced to map all non-standard or User defined material or cross sections in one go. A new algorithm has been developed for mapping the materials and families.

3. The standard materials of Revit will be automatically mapped to the equivalent SCIA Engineer materials without any user intervention.
4. For user defined or non-standard materials, the equivalent materials will be suggested in the unified user interface mapping dialogue. The user could pick the equivalent material from the suggested list or optionally select the equivalent material.
5. The Standard Structural Framing and Column families of Revit will be automatically mapped to the equivalent SCIA Engineer cross sections.
6. For user defined or non-standard families, the equivalent sections will be suggested in the unified user interface mapping dialogue. The user could pick the equivalent sections from the suggested list or optionally select the equivalent section.
7. The user interface for mapping the “Sections, Section Parameters” have been improved by adding appropriate filters. The user will now be able to pick the equivalent section easily with the new user interface.
8. The mapping database is now extended to support all Concrete, Steel and Timber materials for BS, EC-EN, IBC national codes.
9. The mapping database is updated to map all the Revit families listed in the “Revit Content libraries” for UK, US Imperial, US Metric, Belgium and Netherlands.
10. For Standard Revit concrete families and CADS families, the parameters will be automatically mapped during export and import.

Corrections made:

1. An issue with reading the geometry of 2D elements which causes invalid 2D geometry has been fixed.
2. A warning message is now added when the user tried to import the analysis results and opted to ignore the load cases.
3. The properties of the Revit elements were language dependent and hence there were issues while reading or updating the properties. The issue has been fixed now and the properties are made language independent.
4. A crash with section mapping has been fixed now.
5. The options Export as "Unknown" and "Export as Numerical" is disabled for the “File exchange” mode.
6. All Concrete, Steel and Timber materials are now mapped based on the national code.

Version 2017 (Build 297): June 2016

Enhancements:

1. Support for Revit 2017 and Scia Engineer 16.
2. Support for import of “numerical” cross-section in Revit: Members with “numerical” cross-section in Scia were previously excluded and the import terminated. These can now be exported to Revit through standard cross-section mapping.

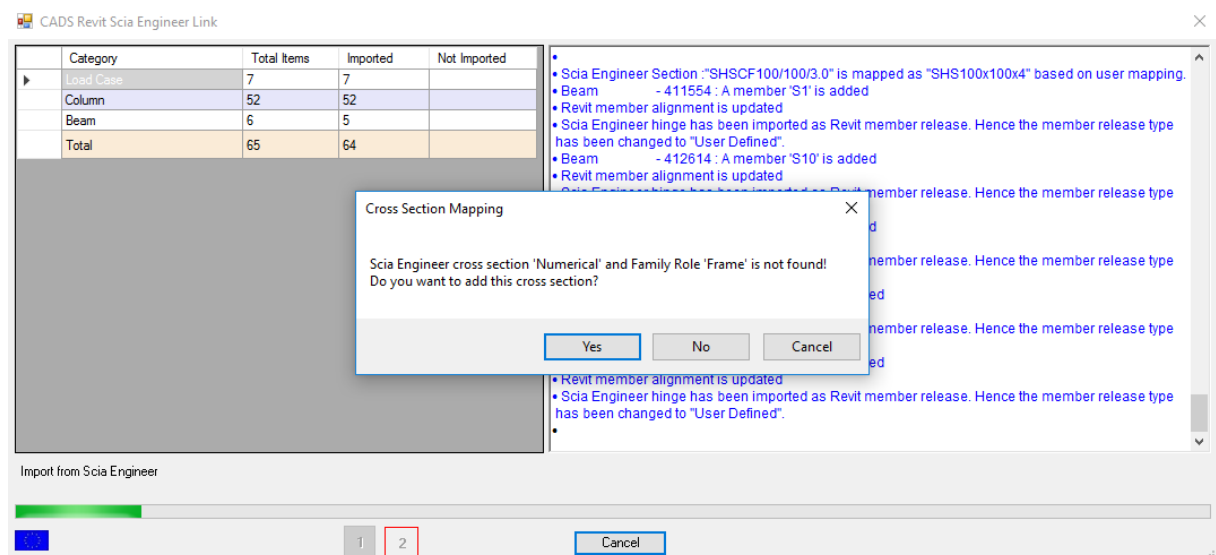

Corrections made:

The following issues have been resolved:

1. The tolerance limit for differentiating vertical and slant columns has been improved thereby fixing an issue where columns had different orientation in Revit compared to Scia. A related issue concerning columns defined from top to bottom has also been fixed.
2. An issue where export was skipping members in a Revit model after encountering a member with 'Enable analytical model' not selected has been fixed.
3. An issue with export and import of plates with just one arc segment from Scia has been fixed.

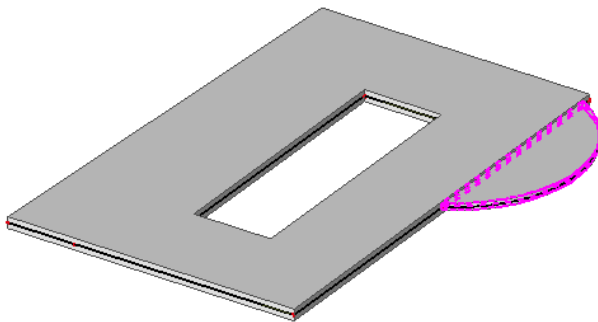

Version 2016 (Build 280): May 2015

Enhancements:

1. Support for the latest versions of Revit and Scia Engineer.

Corrections made:

The following issues have been resolved:

1. An issue with exporting columns when an architectural model is converted into a structural model.
2. An issue with exporting member end releases in certain models.
3. An issue with the Options dialog being blank due to a missing folder in the user path.

Version 3.1 (Build 268): December 2014

Enhancements:

1. Import of analysis results for 1D members and 2D members from Scia Engineer 14/14.1 into Revit 2015 and 2014. It requires Autodesk Structural Analysis Toolkit to be installed.

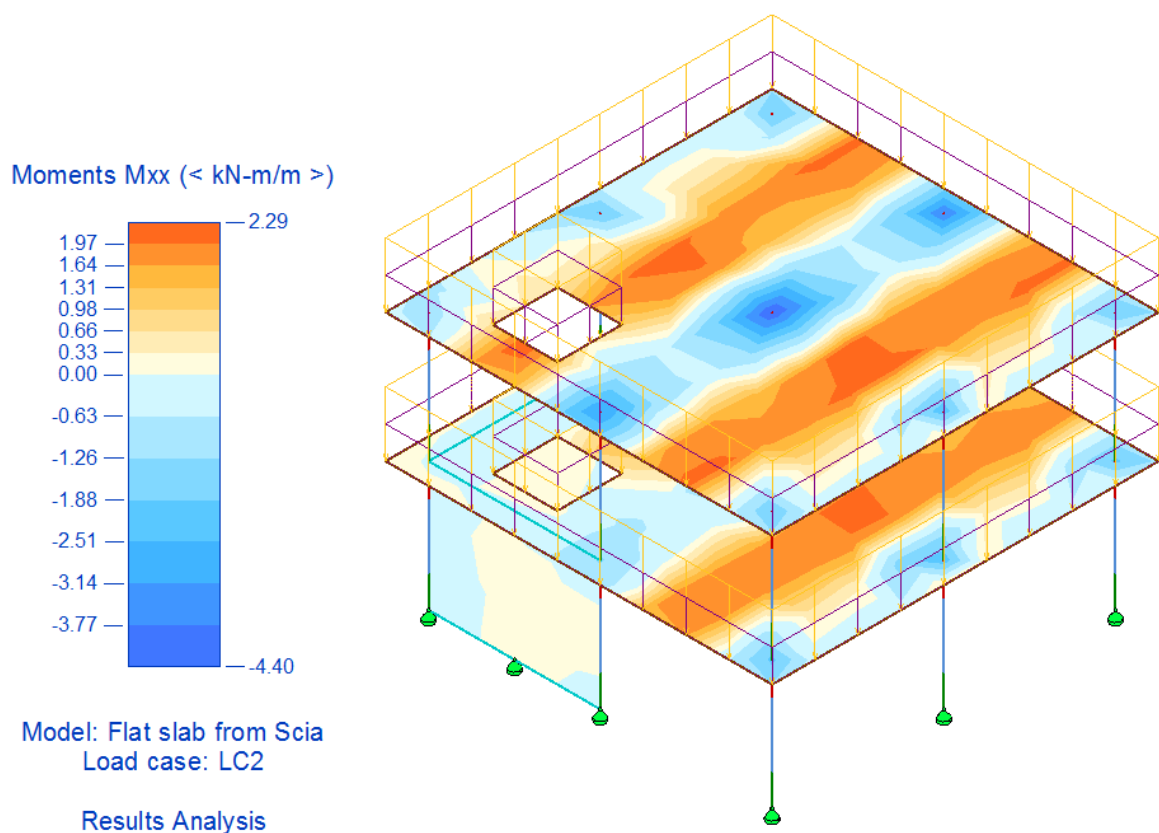

2. Beam end reactions as member properties to tag for connection design with steel members.
3. Import of member end releases from Scia Engineer.
4. Export / Import to non-English version of Scia Engineer.
5. An option to export unmapped section as Scia Engineer numerical cross-section.

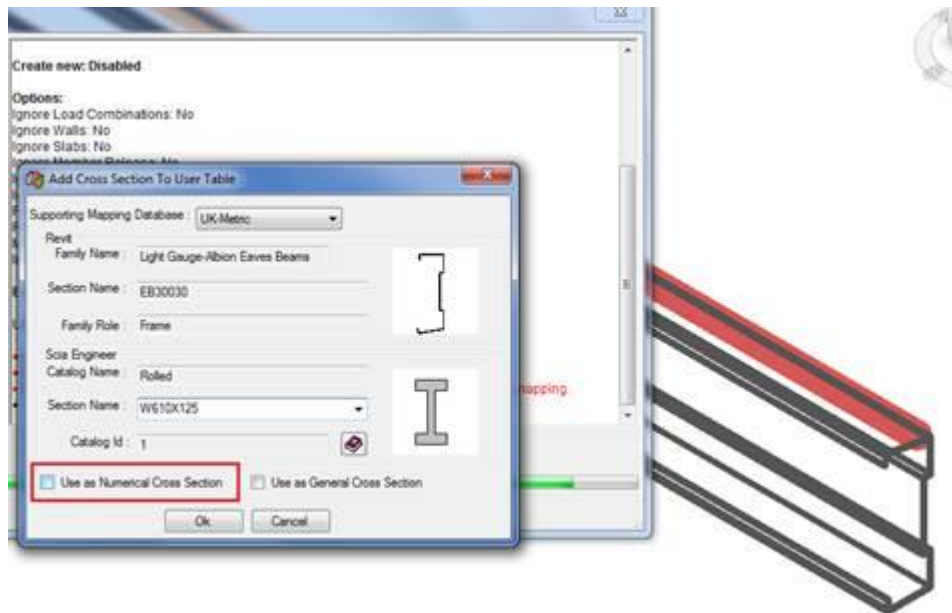

6. Support for masonry and timber materials with Eurocode.
7. Support for export and import of additional timber cross-sections.

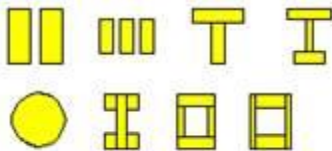

8. Support for slim floors beams:

The standard UK cross-sections from TATA are mapped by default. User mapping will need to be done for other cross sections (such as European sections).

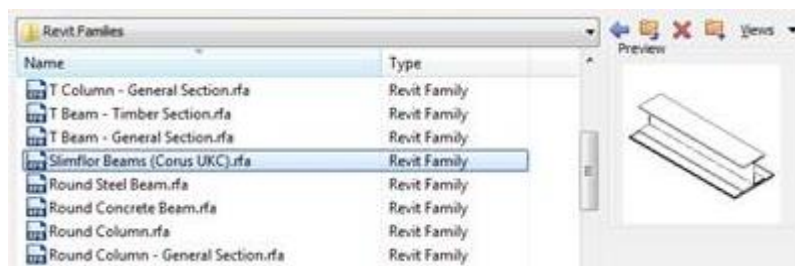

9. User rights restriction has been removed. It is not necessary to run Revit as administrator.
10. Improvements to review manager:
 - ▶ Member deletion in Scia Engineer is listed in the review manager;
 - ▶ New/Modified/Deleted members are coloured distinctly in the preview model.
11. 'Review and Export' feature has been enhanced with an option to ignore the history of previous export / import in order to avoid partial export when the corresponding Scia model is not available to synchronise.
12. Section parameter mapping is now saved with the project hence it is no longer required to remap the parameter when the project is closed and reopened. The mapping can be reviewed and deleted if required similar to user mapping for steel sections.

Corrections made:

The following defects are fixed:

1. Shaft openings are no longer deleted during round trip but any change done to the shaft opening in Scia Engineer will not be updated due to the limitation of modelling in Scia Engineer.
2. Mapping of load category in Revit to a load group in Scia Engineer has been updated allowing import of load cases and load groups created from Scia Engineer.
3. Mapping of cross-section rotation has been updated in this release. Hence continuing the round trip with a job imported / exported from previous release (Revit link 3.0) with this release (Revit link 3.1) may not produce the desired result. It is recommended to use a consistent version of the link during a round trip.
4. The problem with the model not updating correctly using the *Import* button from the options dialog has been fixed.

Version 3.0 (Build 254): May 2014

Enhancements:

1. Support for *Revit Structure 2015* and *Revit Design Suite 2015 [One Box]*.
2. Support for *Scia Engineer 14*.
3. New features are added:

This release presents a new feature for *model review and change management* where you can view the changes to the Revit model and apply only those required to the analysis model in Scia Engineer and vice versa during import.

- ▶ Option to review and export the Revit model;

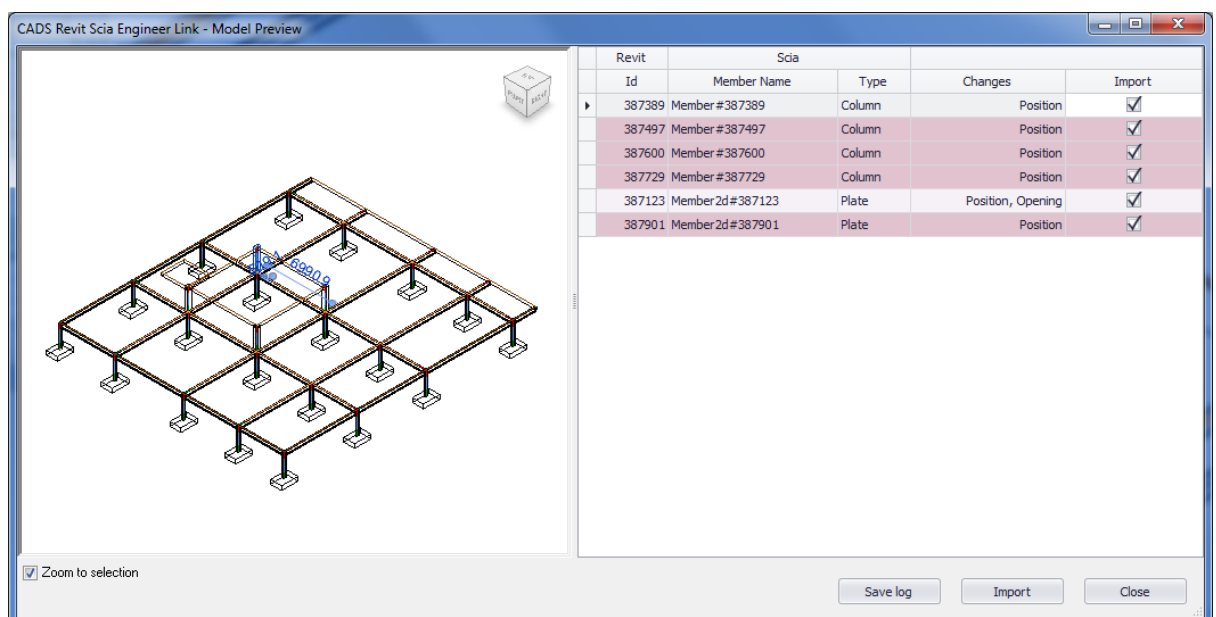

- ▶ Option to review and import the Scia Engineer model;

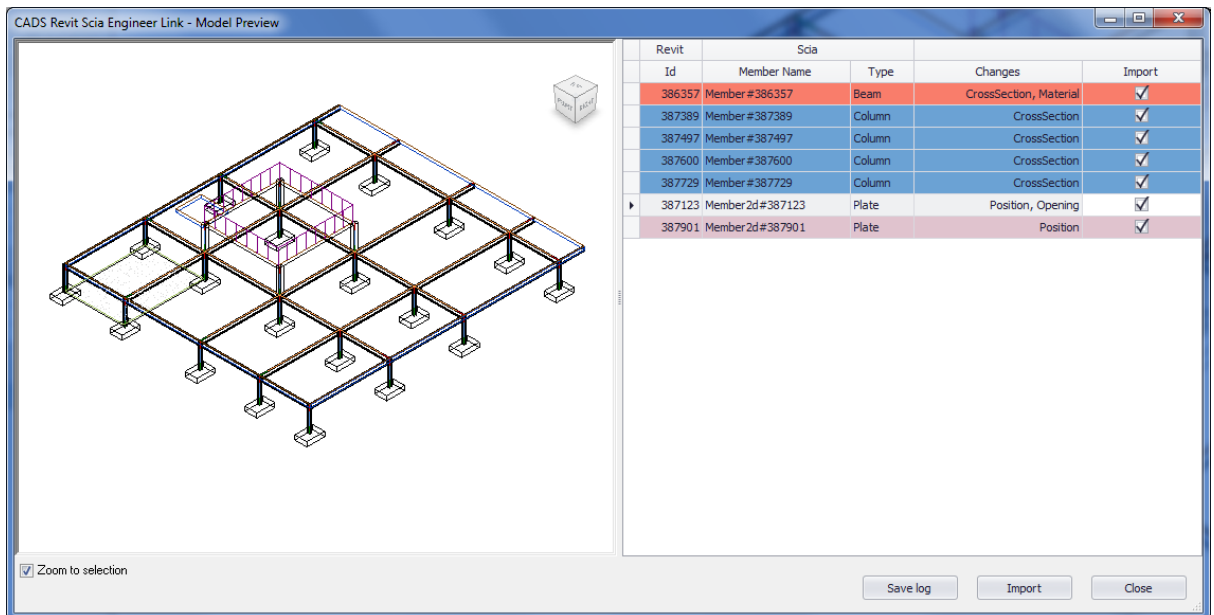

- ▶ On export a warning is displayed if there are any analytical model consistency check errors or warnings;
- ▶ Option to configure the Node name format.

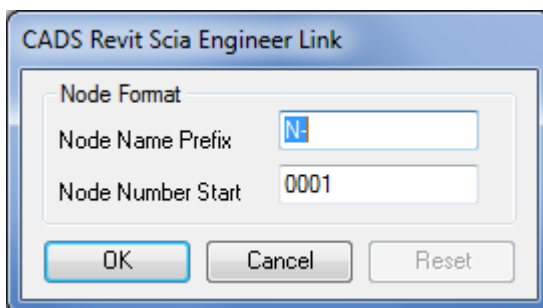

- Options dialog has been enhanced to display the national code image.
- The log has been enhanced to display the current options.

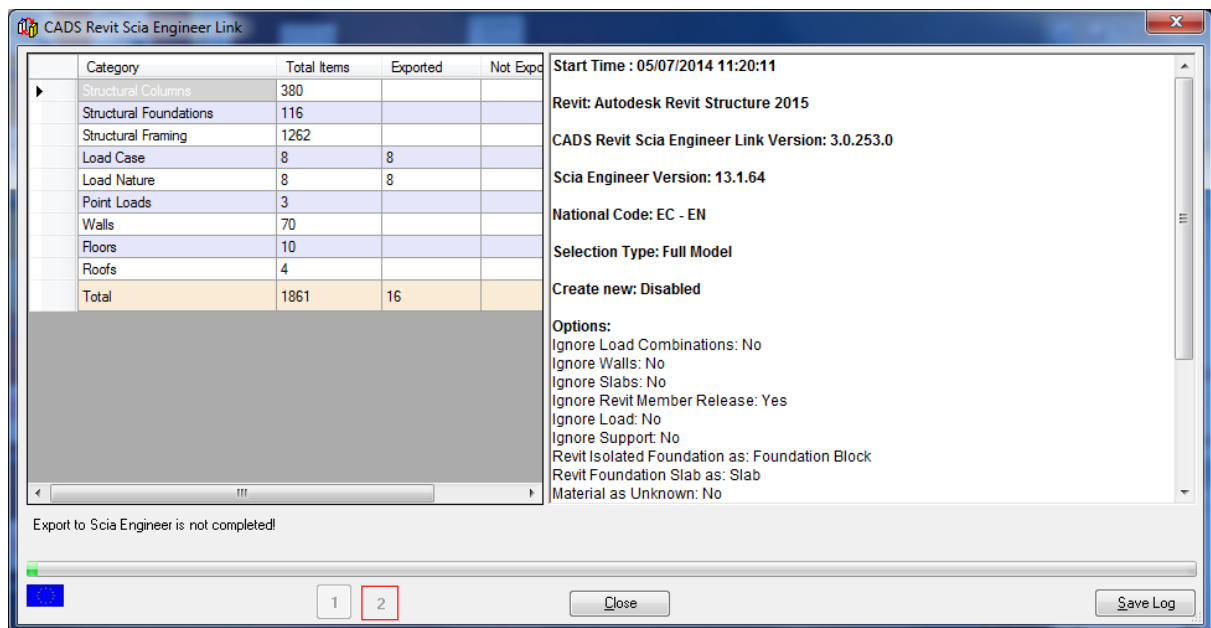

6. The icons in the CADs Revit Scia Engineer Link ribbon are replaced with new icons and rearranged.

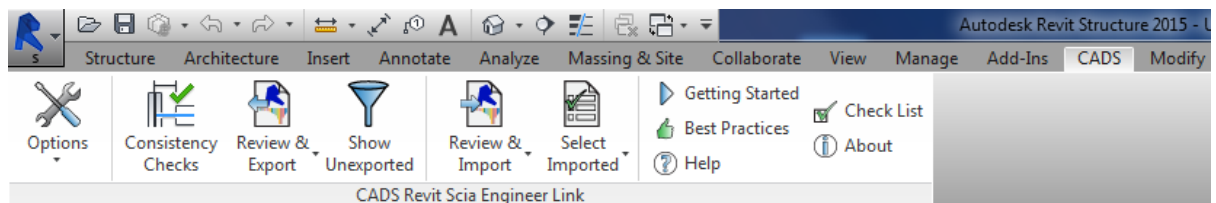

Corrections made:

- The following defects are fixed:
 - ▶ Error on exporting HEA section from Revit;
 - ▶ Appropriate units for cross section parameter mappings based on the current Revit model units;
 - ▶ Skipping invalid line loads on import;
 - ▶ Isolated foundation is exported with zero height.

Version 2.2 (Build 244): June 2013

Enhancements:

- Support for Revit Structure 2014 and Revit Design Suite 2014 [One Box].
- Support for Scia Engineer 2013 version.
- Configuration option "Ignore Revit Load Combinations" has been renamed as "Ignore Load Combinations" and load combinations will be ignored for both export and import.
- "Section Parameter Mapping" feature implemented.

5. Configuration Options dialog redesigned and the application moved to “CADS” ribbon in Revit from “Adds In” ribbon.
6. Support for a number of cross sections created using “Geometric shapes” feature in Scia Engineer:
 - ▶ I ng (Asymmetric I Section);
 - ▶ I gh (I Section);
 - ▶ Rectangle;
 - ▶ Circle;
 - ▶ Oval;
 - ▶ T g;
 - ▶ L g;
 - ▶ U g (C Section);
 - ▶ Tube;
 - ▶ X;
 - ▶ Z;
 - ▶ O;
 - ▶ C (Box C Section);
 - ▶ Asymmetric.
7. Support for rectangular columns created using “Arbitrary Profile” feature with two cross sections and default, centre line, Top surface and Bottom surface alignment in Scia Engineer.
8. Support for “Ribbed Slab” 2D element in Scia Engineer.
9. Support for the following cross section profiles available under “Concrete Sections” in Scia Engineer:
 - ▶ I ng (Asymmetric I Section);
 - ▶ Rectangle;
 - ▶ Circle;
 - ▶ Oval;
 - ▶ T g (only for Beam category);
 - ▶ L g;
 - ▶ L-g (Inverted L).
10. Support for “General cross –sections” in Scia Engineer when imported into Revit.
11. New configuration options provided to export foundation slabs from Revit to Scia Engineer as slabs, foundation or as specified in Revit Structure “Analyse As” option.
12. New option to ignore load while importing or exporting the model has been added.
13. New feature implemented to use default material when an element’s material is set as “By Category” in Revit.
14. New option to show cross section profile image while adding cross sections to the user table.
15. Configuration option “Overwrite Scia Engineer supports” option is now renamed as “Ignore Supports”.
16. New feature to support 1D element “move” in Scia Engineer for subsequent import into Revit.
17. Fix to delete members in Scia Engineer or Revit Structure.
18. Fix to cross section mapping routine while importing Unknown cross sections from Scia Engineer.

19. Fix to ensure internal edges have been exported to Scia Engineer.
20. Fix to filter vertical elements drawn using "Plate" 2D member type in Scia Engineer.
21. Fix to cross section mapping tables GUI for inappropriately switching from materials library in a particular sequence.
22. Fix to update R2S file into Scia Engineer using Update->Revit file feature to ensure the nodes do not get scattered.
23. Fix to Scia Engineer->Update->Revit file option to ensure the nodes do not get interchanged in a particular sequence.

Version 2.1 (Build 220): July 2012

Enhancements:

1. Support for Revit Structure 2013 and Revit Design Suite 2013(OneBox).
2. Support for Scia Engineer 2012 version.
3. Cross sections and material database updated for Revit Structure 2013 and Scia Engineer 2012.
4. Shaft openings are now supported.
5. Export/Import dialog enhanced to show the log of events as they happen.
6. All type of eccentricities as defined in Revit Structure or Scia Engineer are now handled. Warning messages during the export/import process are given in the Log file if some eccentricity cannot be mapped owing to limitations in Revit Structure.
7. New document with best practices advice can be accessed directly from the Ribbon menu.
8. Check List introduced to help contact the support team with general application queries.
9. Fix for application crash in Revit Structure in a specific sequence.
10. Fix for opening not exported to Scia Engineer in a specific sequence.
11. Fix for sloping beams to report proper end conditions when imported into Revit Structures.
12. Fix to export copied members in Revit Structure in a specific sequence.

Version 1.5 (Build 195): May 2010

Enhancements:

1. Support for 64 bit version of Revit Structure.
2. Support for Scia Engineer 2010 version.

Limitation:

1. Loads do not get imported in Revit Structures from Scia Engineer 2010.

Version 1.4 (Build 177): August 2009

Enhancements:

1. Supports Revit Structure 2010.
2. Hollow core sections can be exported from Revit Structure to Scia Engineer (material will not be exported).
3. Slanted columns are supported.
4. Timber material is supported for BS code.
5. Mapping database is updated for Revit Structure 2010.
6. UK Advance Steel section has been implemented.
7. Holes added to an existing slab in Scia Engineer can be exported to Revit Structure 2010.
8. Foundation slab for columns and beams can be exported as a boundary condition when the option “structural usage= foundation” is set.

Version 1.3 (Build 173): July 2008

Enhancements:

1. Supports Revit Structure 2009.
2. A Cancel command has been added to the export progress window.
3. Cross sections in Revit can be exported as General cross sections in Scia Engineer (hollow sections are not supported).
4. Rectangular and round steel members are now supported.
5. The log window shows the cross sections that have been exported so they can be checked with the cross section library in Scia Engineer.
6. Performance has been improved when exporting models created in Scia Engineer to Revit.

Corrections made:

1. Various fixes have been applied to the mapping database.
2. When a model is partially exported, only the selected members are now shown in the log window.
3. Under certain circumstances, the same cross section was being duplicated in the cross section library. This has now been resolved.
4. The member release data was incorrectly mapped and this is resolved. i.e. the member hinge in Scia Engineer now maps “Revit.Fx” as “Scia.Ux” and “Revit.Mx” as “Scia.fix” etc.

Version 1.3 (Build 169): May 2008

Enhancements:

1. Supports Scia Engineer 2008 onwards.
2. The options dialog is improved using the property palette.
3. Foundation slab as raft has been included.
4. Isolated foundation as foundation block has been included.
5. Member releases have been exported as hinges.
6. Creation of new members from Scia Engineer to Revit also creates appropriate levels.
7. The user mapping table can be accessed through the options dialog using a button.
8. The user mapping table content cannot be edited but the sections can be added / deleted using commands.
9. A material or cross section can be exported as “Unknown” material or cross section.
10. The log window uses colour codes to show the error or warnings.
11. A filter command is added to show the non exported members.
12. Progress dialog includes export summary and error log.
13. Error Log information can be saved.
14. The Release notes can be launched from the “About Box” dialog.

Corrections made:

1. Imperial members, when created as new uses the appropriate imperial length in the section names.
2. Automatic Cross section mapping dialog lists members according to the family role.
3. Members set as “not for analysis” will not be exported and shows the reason in the log list.
4. Separate national code is listed for the Imperial template with metric units for the LRFD code.
5. Analytical line error during updating the truss has been corrected.
6. Validations have been added in the material or section chooser dialog so that the user cannot enter a value.
7. The catalogue name in the material chooser dialog has been renamed using appropriate names.
8. The national code names for America have been renamed appropriately.
9. In place structural columns and framings are supported for rectangular cross section.
10. Rigid link in columns has been exported as a stiff bracket that supports beams.
11. L-shape, T-shape, Single Tee and Double Tee frames are supported.
12. Precast rectangular column with chamfer is supported.
13. Wooden frames and wooden columns are supported.

14. A validation has been added to exclude the export of the Curtain wall.
15. Slabs with spline edges are supported.
16. When the wall bottom is formed with a step profile, the wall foundation exports correctly.

Version 1.2 (Build 153): December 2007

Enhancements:

1. Command button for Help file included along with the help file.
2. Command button for "About" included. Selecting this will display a dialog showing the version information.

Corrections made:

1. In the rules based source/target configuration dialog, after editing and saving caused to restore default delimiters. This has been fixed.
2. In some of the machines, the rules based source/target configuration crashed the link.
3. If a truss is exported and updated, the update process did not work and gave an error message.
4. There was an error displayed when exporting beams with "Analysis As" parameter set to "Not for analysis".
5. If the structural usage of the frame is other than the girder, LCS rotation and the Member system line did not export correctly.
6. If moment load is used, it gave an error which has been resolved.

Known Issues

S.No.	Known Issues
1.	If the members are created using poly line in SCIA Engineer, creating new in Revit does not work.
2.	Creating a model from SCIA Engineer to Revit requires a Revit job to be open which is created using an appropriate Revit template (e.g. Structural Analysis-DefaultEUROENU.rte for Euro code and Structural Analysis-DefaultGBRENU.rte for BS code)
3.	Elliptical hole can be exported from Revit to SCIA Engineer but it is not possible to import from SCIA Engineer.
4.	Intersecting openings is exported as a single opening in SCIA Engineer.
5.	Hosted line loads created on a 2D member edge in SCIA will be imported as a free line load for that edge because of the limitation in Revit.